



Elevator Technology

AGILE

Destination Controls



thyssenkrupp



AGILE – Destination Controls — inside and out.



Contents

What is AGILE – Destination Controls?	02	Advanced controls and operations	14
Advantages	02	Pedestals	16
Quicker, clever and more nimble	03	Embedded and standing pedestals	17
Make the smart move to greater efficiency	04	Wall covers	18
Adapt our controls to fit your needs	06	Standard half-height	19
Get to know our kiosks	07	Slim wall covers	20
Kiosks	08	Full-height	21
Large kiosk	08	Half-height	21
Small kiosk	10	Additional devices	22
Turnstile display	12	Hall target indicators	22
Modules	13	Floor and elevator identification	23
Kiosk specifications	13	In-car devices	24

What is AGILE – Destination Controls?

AGILE – Destination Controls is an advanced dispatching system that directs passengers to the elevator that will get them to their destination in the shortest travel time. By grouping people together based on the floor they are traveling to, the number of stops is reduced — thereby improving the efficiency of the building’s elevator traffic.

Advantages

More handling capacity and better performance.

An elevator enhancer that you can add to virtually any elevator, this system is designed to move people to their destination in the quickest way — whether the building is new or existing, mid-rise or high-rise.

More security options.

Card readers can be set up to increase security, separate passengers from staff, designate an elevator’s floor destination or reduce staff’s travel time, which increases their production time.

More modern and easily customizable.

Kiosk displays can be customized to send messages to the tenants or share announcements of building events. Button size, shape and names can be customized to further a tenant’s brand recognition or show where the common areas are located.

More flexibility.

Various configuration options create nimble solutions no matter who is occupying the building. Whether it’s a hotel, hospital, office, residential building, commercial building or a multi-use building, AGILE – Destination Controls can be configured to display a unique interface between the passenger and their destination.

Quicker, clever and more nimble.

15 stops vs. 4 stops

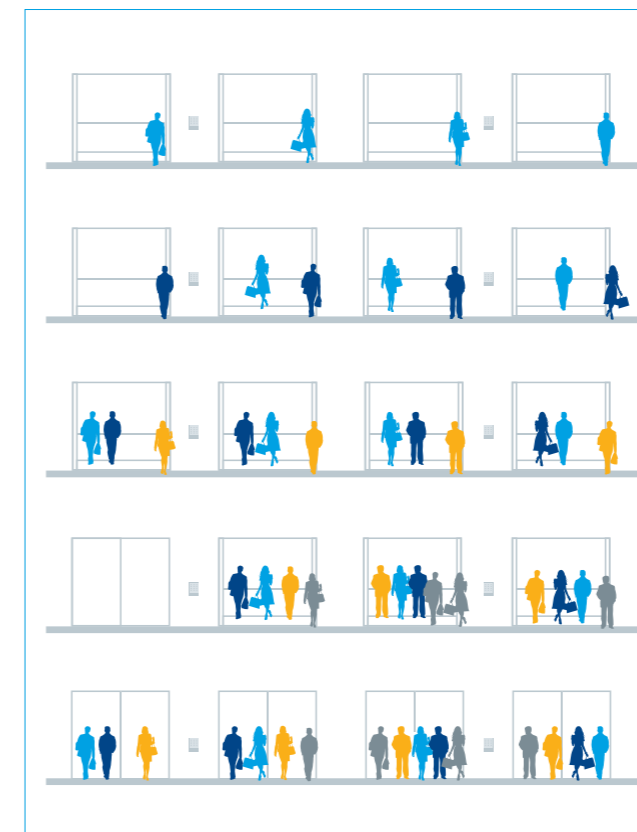

Traditional operation

With a traditional elevator system, 16 passengers would crowd into the lobby and board the first available car. Therefore, it could take as many as 15 stops for some tenants to reach their floor.

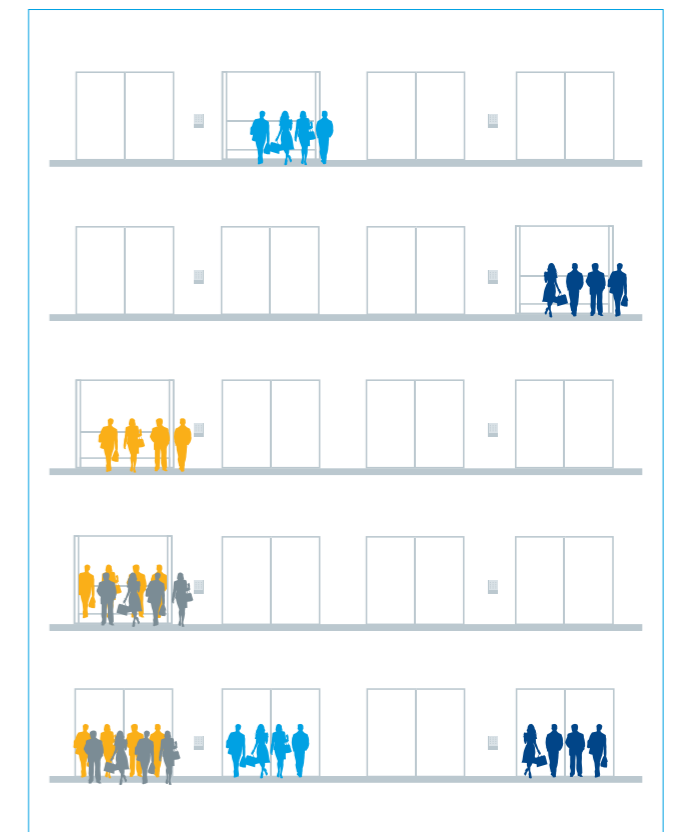

AGILE – Destination Controls operation

AGILE directs the 16 passengers to dedicated elevators so they reach their destinations in less overall stops.

Make the smart move to greater efficiency.

How it works

AGILE – Destination Controls intelligently groups passengers traveling to similar floors together. This technology is designed to reduce wait times for all tenants. A traditional dispatching system analyzes a hall call and assigns the “best-available” elevator to

respond the fastest. However, during the elevator journey, multiple stops can delay passengers going to other floors. With AGILE technology, each elevator trip is more efficient due to fewer stops along the way, which results in shorter times to destination.

Step 1

Passengers use the kiosk to select their floor. You can add custom button labels and logos to make the process even easier.

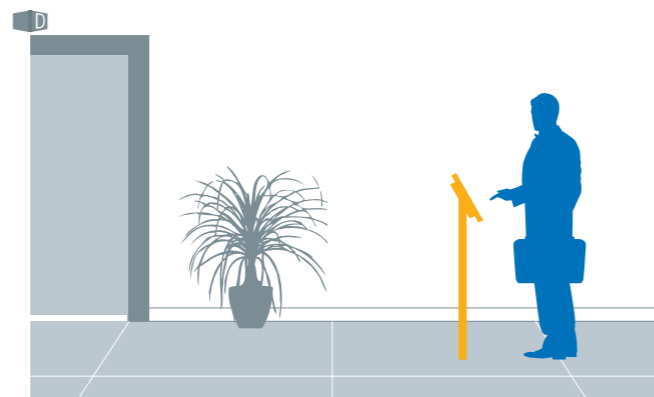

Step 2

AGILE clearly directs each passenger to an assigned elevator.

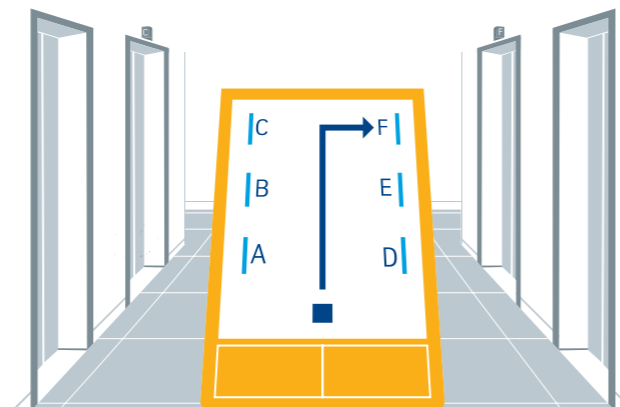

Step 3

Passengers board the assigned elevator that transports them to their destination fastest.

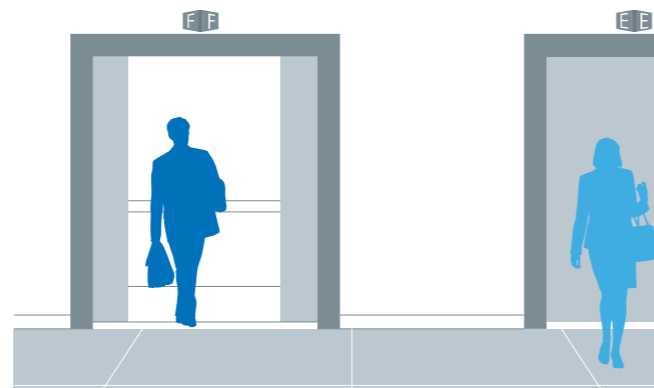

Improving the passenger experience

Traditional elevator operation

Passengers crowd into lobbies and push elevator buttons, which only register limited information — just single “up or down” requests. Then they board the first elevator to answer the call.

This is known as Estimated Time of Arrival (ETA) dispatching that leads to crowded cars, additional stops and remaining passengers who are left behind to wait for the next elevator.

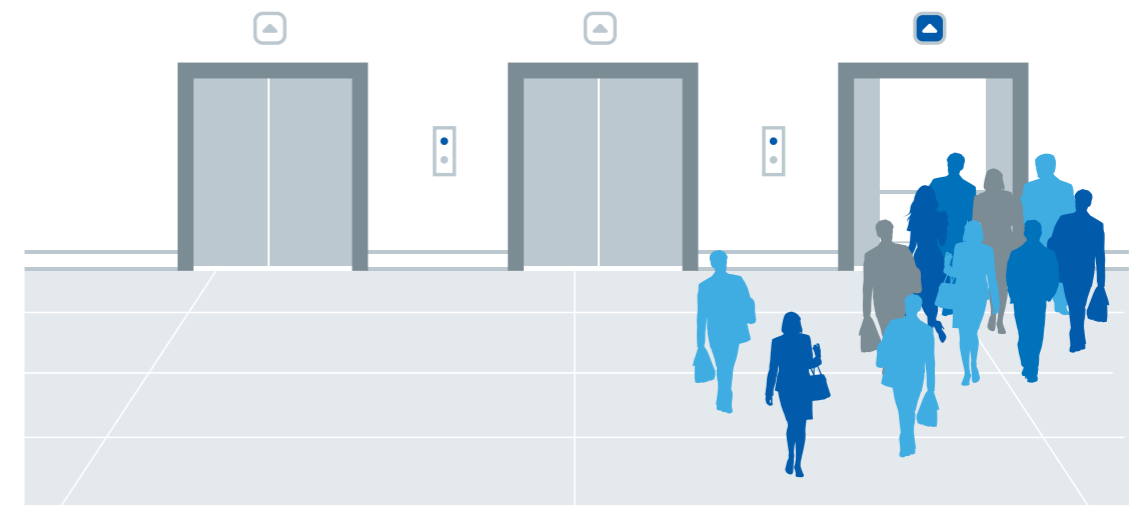

Operation with AGILE – Destination Controls

Passengers use a kiosk to select their floor. The intelligent dispatching software collects their information, analyzes their requests, gauges traffic demand and groups them based on

similarity of destination. This is known as Estimated Time to Dispatch (ETD), which leads to less crowding, fewer stops and a more efficient use of available elevator capacity.



Benefits:

- Less congestion in the lobby at high traffic times
- Increased handling capacity by up to 30 percent
- Improved passenger comfort with less crowded elevators
- Reduced travel times by as much as 25 percent
- Competitive building amenity for attracting and retaining tenants

Adapt our controls to fit your needs.

AGILE – Destination Controls is flexible enough to seamlessly adapt to new and existing elevators — even during a modernization.

Destination Complete

This configuration takes advantage of all that AGILE – Destination Controls provides — and is available on elevator modernization projects, new installations or as a retrofit to a recently installed thyssenkrupp elevator system.

Key features and benefits:

- A kiosk at every floor
- No push-buttons inside of car
- Maximum efficiency
- Ideal for complex buildings
- Easily integrates with existing security system

Destination Select

If your building has high-traffic conditions on only a few floors, then AGILE – Destination Controls is a cost-effective solution.

Key features and benefits:

- Kiosks at main floor or selected floors
- Push-buttons inside of car
- Improved efficiency in select areas
- Ideal for buildings with high traffic during peak hours on certain floors
- Easily integrates with existing security systems



*In high-traffic areas only, such as a lobby or cafeteria.

Get to know our kiosks.

Motion sensor

Changes display brightness when motion is detected and dims when there is low traffic or no motion near the kiosk.

Ambient light sensor

Adjusts the display brightness based on the amount of natural light available.

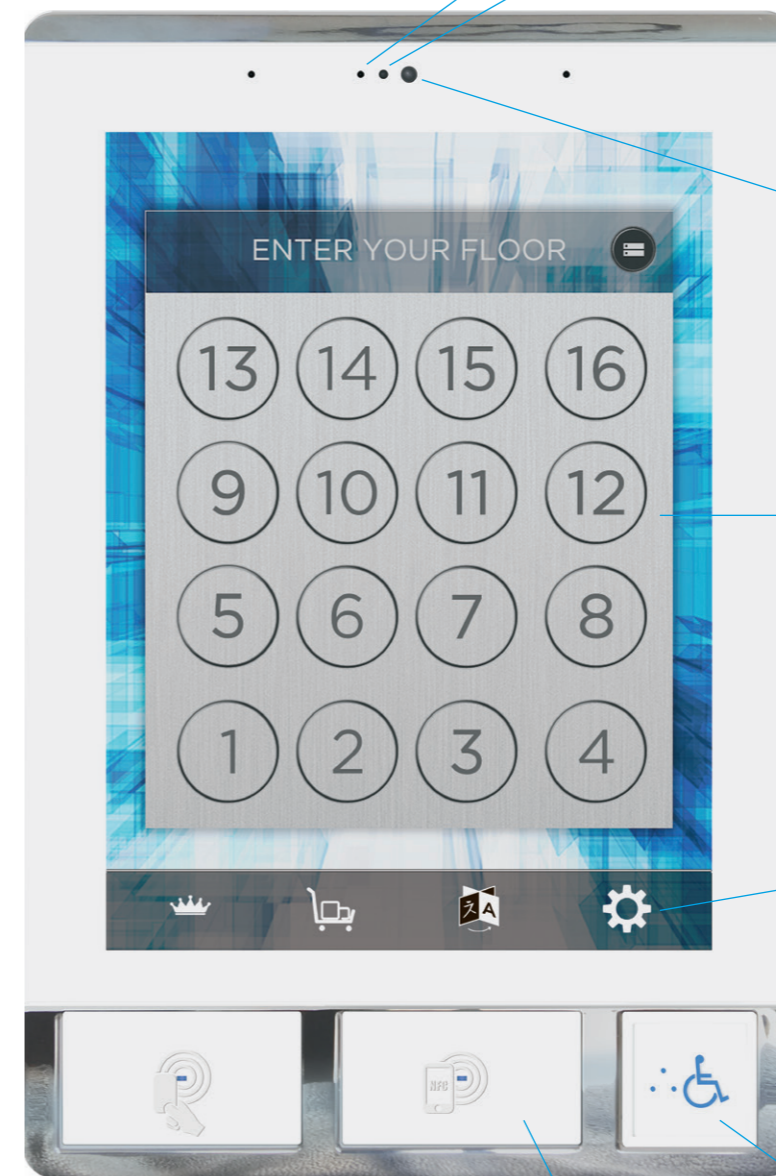

Camera

Used for a variety of features requiring computer vision, such as image capturing, QR codes, facial recognition and more.

Touchscreen

Entry point for selecting the destination and also shows the direction to the assigned elevator.

Dock area

Used for getting to settings, opening the help screens and various other functions.

Americans with Disabilities Act (ADA) button

When pressed, voice announcements and signal lighting activate to help disabled people reach their destination.

RFID card reader and NFC modules

The kiosk features space for an optional RFID card reader and/or Near Field Communication (NFC) hardware. It's designed for quick, touch-free access to secure floors and will enable special features. Modules will vary by kiosk and job-specific requirements.



Large kiosk

Touchscreen

Black anodized aluminum frame with black-edged screen



Finish options

Polished aluminum frame with black-edged glass screen



Polished aluminum frame with white-edged glass screen

Kiosk dimensions

Large Touchscreen	Dimension in inches (mm)
Height	14" (355 mm)
Width	9.29" (236 mm)
Angled wall mount thickness	4" (102 mm)
Flush wall mount thickness	2.56" (65 mm)

Kiosk display information

Display size	12" diagonal
Resolution	1024 (H) x 768 (V) pixel
Display colors	16 million
Ratio	4:3
Backlight life	50,000 hours
Mode	Normally white
Brightness	400 cd/m ²

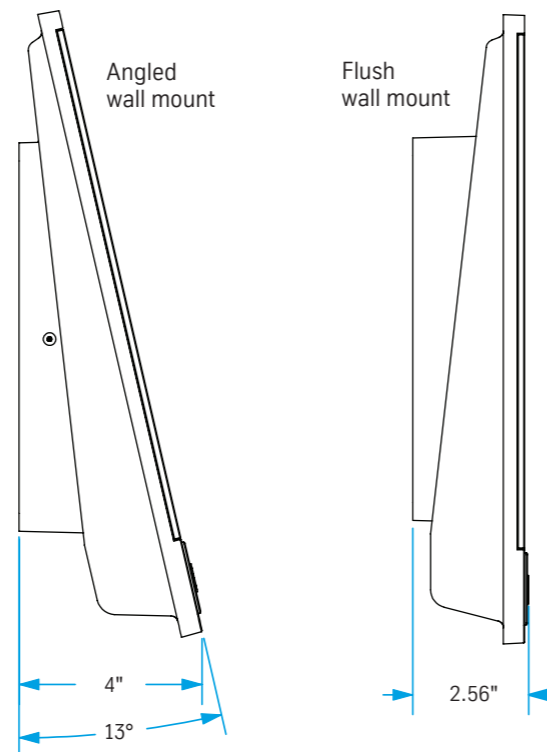

Small kiosk

Touchscreen

Black anodized aluminum frame with black-edged screen



Small kiosk dimensions

Small touchscreen	Dimension in inches (mm)
Height	9.73" (247 mm)
Width	4.63" (118 mm)
Thickness (angled)	3.39" (86 mm)
Thickness (flush)	2.31" (59 mm)

Small kiosk display information

Display size	7" diagonal
Resolution	1280 (H) x 800 (V) pixel
Display colors	16 million
Ratio	16:10
Backlight life	50,000 hours
Mode	Normally white
Brightness	400 cd/m ²

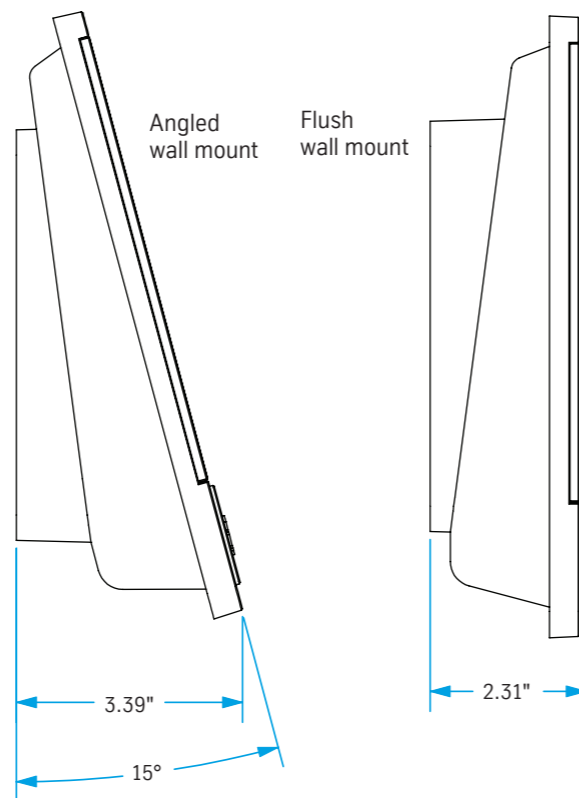

Finish options

Polished aluminum frame with black-edged glass screen



Polished aluminum frame with white-edged glass screen



Turnstile display

Another benefit of AGILE – Destination Controls is its easy integration into a building’s security system. A turnstile security system may already exist — or may be in the planning stages. If this is the case, a smaller kiosk display (without modules) is available to direct passengers to their floor, once they have swiped their security card at the third-party card reader.

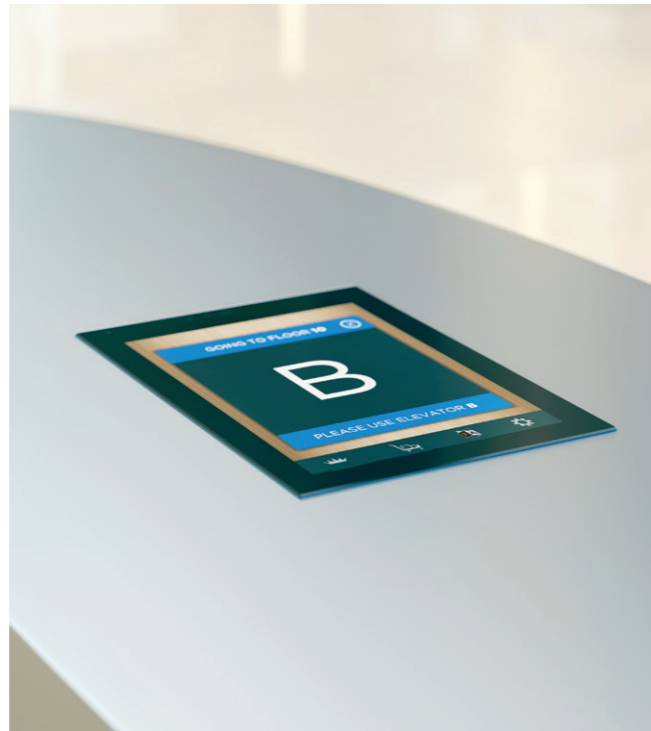

Turnstile kiosk dimensions

Height	9.6" (245 mm)
Width	4.2" (107 mm)
Thickness (angled)	3.5" (90 mm)
Thickness (flush)	2.4" (62 mm)

Turnstile display information

Display size	7" diagonal
Resolution	1280 (H) x 800 (V) pixel
Display colors	16 million
Ratio	16:10
Backlight life	50,000 hours
Mode	Normally white
Brightness	400 cd/m ²

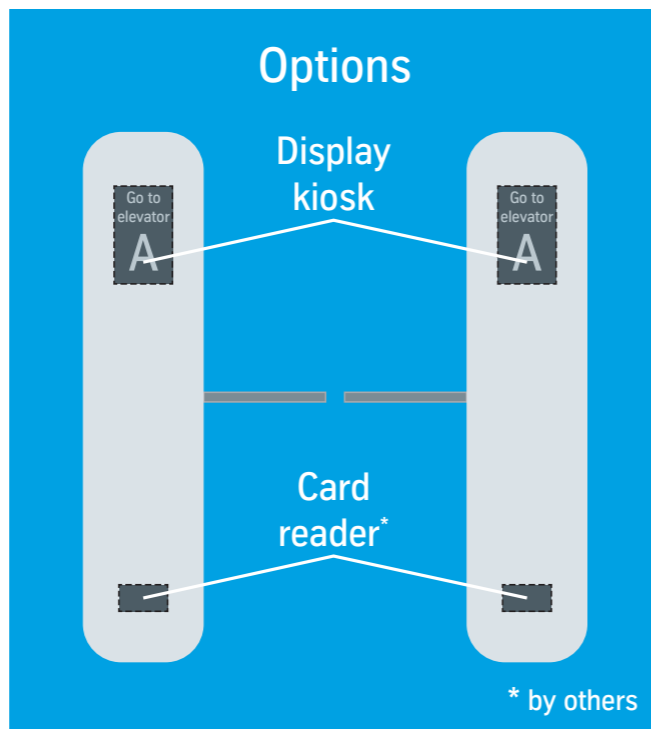

Modules



Card reader

A card reader featuring contactless technology is an available option. This will allow users to quickly present their card and gain access to a secure floor or special features.

Near Field Communication

This optional module will allow for expanded connectivity options to compatible devices, accessories and chips — keeping your device equipped for the future.

Tactile ADA button

Complies with the guidelines set forth in the Americans with Disabilities Act to ensure all users can efficiently move to their destination.

Kiosk specifications

Display colors	16 M color
Brightness	400 cd/m ²
Backlight LED	50,000 hours (lifetime on full brightness)
Power requirement	Power over Ethernet (PoE)
Operating system	Linux
CPU	Freescale i.MX6 dual-core
DRAM	1GB DDR3L
System storage	4GB NAND flash
Communication	Ethernet or PoE, CAN, RS-232
Ethernet network	10/100 Mbps
Card reader	HID iCLASS SE® reader module
Rating	IPX3
Temperature (operating)	0 to 50 degrees C (32 to 122 degrees F), indoor use only
Standby mode	Yes, after a period of inactivity (time period is adjustable in the Design Center application)

Advanced controls and operations

Take control of your building's operations.

AGILE – Destination Controls puts you in control so your elevators can adapt to the diverse needs of the people that use them each day. All of these features can be controlled by using our kiosk.

Available features



ADA voice capability

Your elevators need to be accessible to everyone. With ADA voice capability, visually impaired passengers simply press the ADA button to register calls and audible announcements direct them to their assigned elevator. Upon arrival at their destination floor, an announcement tells them to exit.



Capture

Authorized users can select and recall specific elevators to specific floors using a kiosk or other destination input device. Once captured, the elevator car can be placed on independent service to give users control of the car to clean the interior or perform maintenance. This function can be operated via PIN entry or card swipe.



Code Blue

In hospitals, seconds count and Code Blue calls the first-available elevator car with a quick card swipe or PIN entry. It can also call designated cars in a particular order — in case hospitals have limited elevators large enough to accommodate stretchers, or limited access to floors where operating and emergency rooms are located.

A Code Blue call removes the car from automatic operation, delivers the user to the destination floor and then returns to automatic operation. That way, your elevators are flexible enough to serve daily passengers and critical trauma patients.



Design center

Display appearance, such as background, button shape, card area visibility and even messages can be modified using the Design Center application. Customize the dock configuration to enable additional features. You can also set parameters affecting just one or all of the kiosks in your building from one location.



Express operation

Maximize the trip speed with Express operation. Program selected elevators to be cycled continuously between two floors for a pre-determined duration. For example, this feature can help hotels transport food efficiently from their kitchen to a ballroom on another floor. You can also prevent other guests from boarding to provide your banquet guests with VIP treatment.



VIP operation

Often, tenants pay a premium to reside on the top floors. VIP operation allows them to swipe a card or enter a PIN to isolate the elevator and provide uninterrupted access to their designated floor. VIP operation provides your upper-floor tenants with a premium ride.



Service operation

Service personnel can use this function to call an empty elevator and ride it nonstop to their destination floor. The user simply registers a call via a card swipe or PIN entry that is pre-programmed to grant access. This is especially useful for hospital employees who transfer patients requiring privacy between floors. Also, delivery personnel using a dolly would require an empty elevator.



Featured:
Large touchscreen kiosk in black anodized aluminum frame with black-edged screen.

Direct wall mount shown is ideal for new construction.

Pedestals

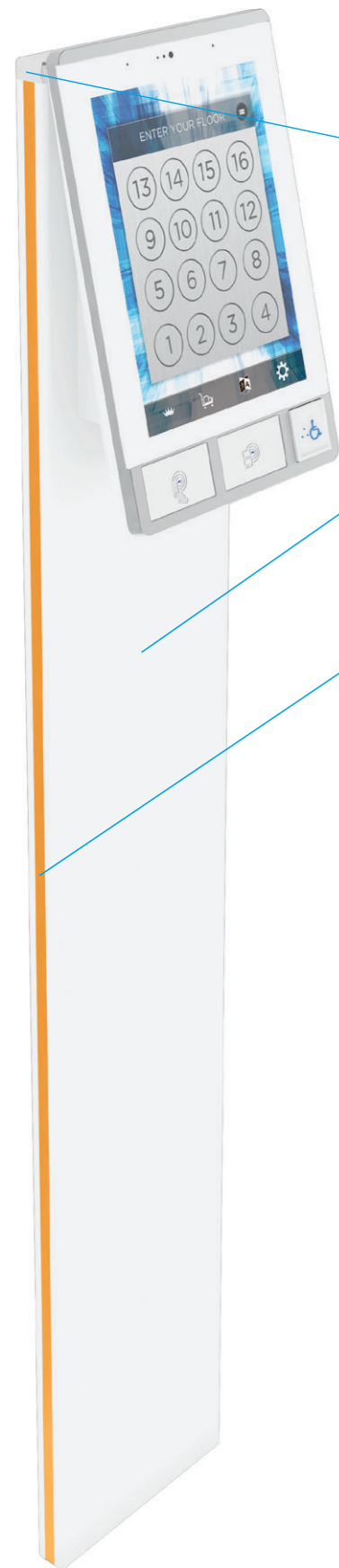

Cap (top only) Available in the following finishes:

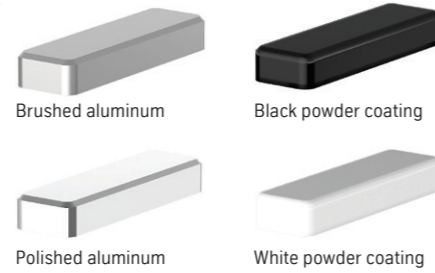

Pedestal body

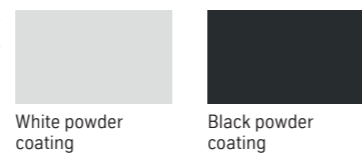

Side cover

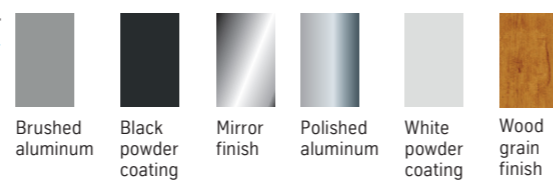

Optional LED side cover colors

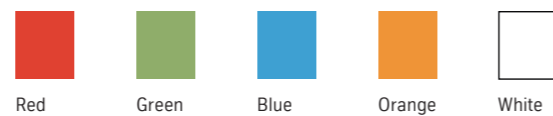

Combined dimensions

Large kiosk

Small kiosk

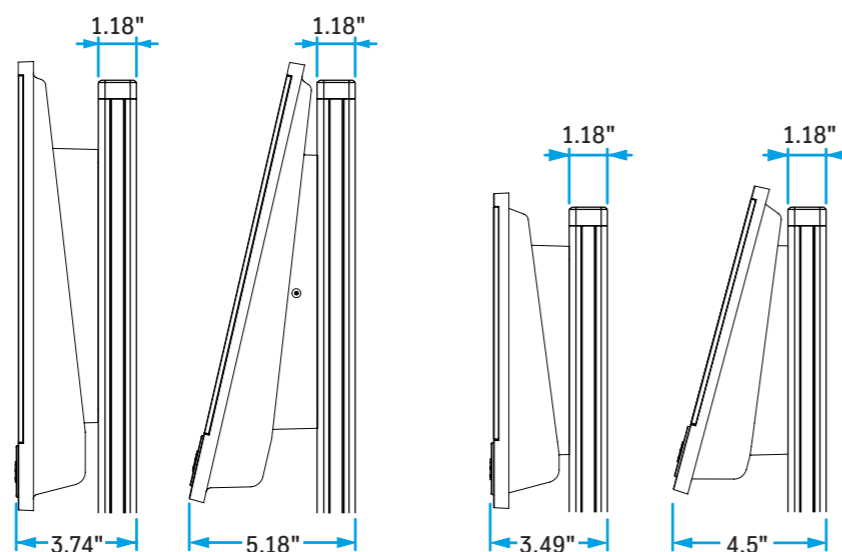

Embedded pedestal

Standing pedestal



Pedestals are only available in the Thick Pedestal Configuration, giving you the option to choose a side cover for your pedestal. The ADA button's center line must be 42" above finished floor (AFF).

Pedestal dimensions

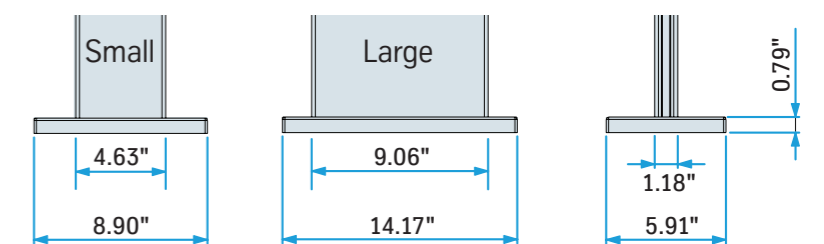

Small kiosks will have a shorter height pedestal to maintain the 42" dimension.

Wall covers



Cap (top) Available in the following finishes:

Bottom cap to match

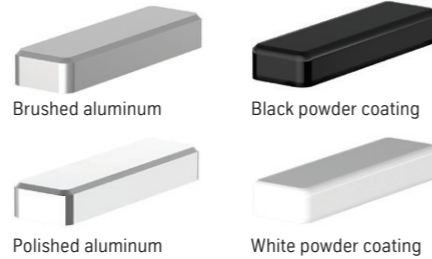

Body

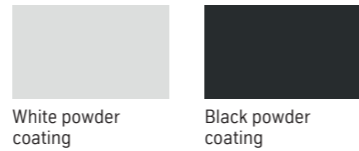

Side cover

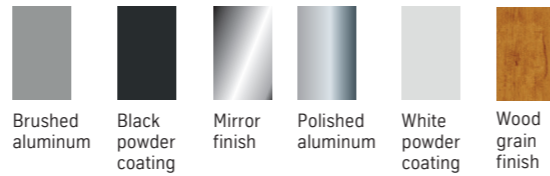

Optional LED side cover colors

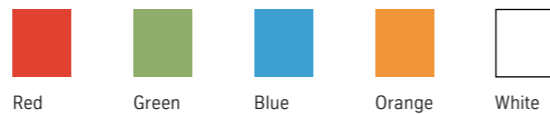

Distance from wall

Large kiosk

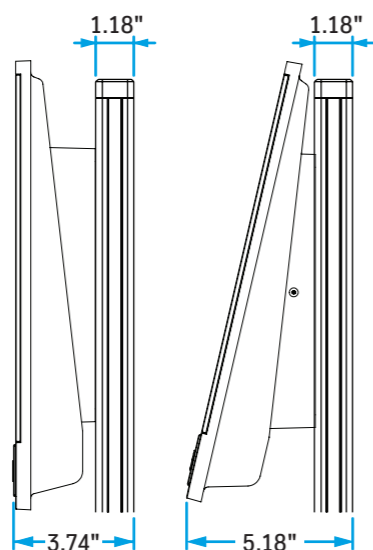

Small kiosk

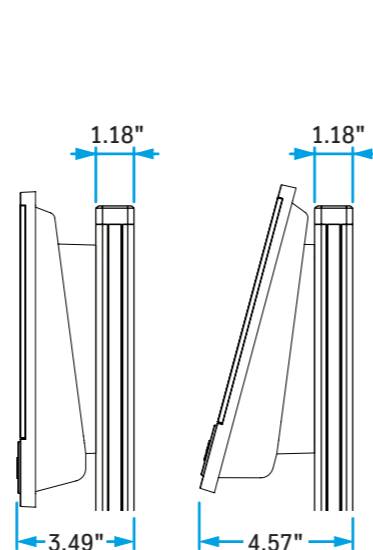

Contact your local thyssenkrupp representative regarding local building code requirements.

Standard half-height

Standard half-height wall covers are only available in the Thick Pedestal Configuration, which gives you the option to choose a side cover to suit your lobby décor.

Wall covers are designed for modernization projects. New construction projects do not require a cover for the kiosk and can be mounted directly on the wall.



Large cover with large kiosk

Large cover with small kiosk

Half-height wall cover dimensions

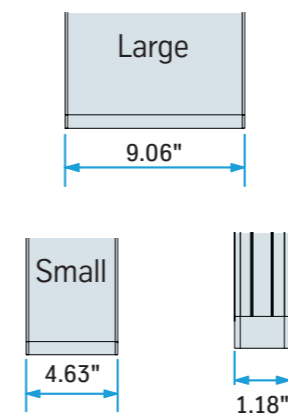

Wall cover heights are all the same and mounted so that the center line of the ADA button maintains 42" above finished floor.



Small cover with small kiosk

Alternative kiosk mounting

Slim wall covers

Cap (top) Available in the following finishes:
Bottom cap to match

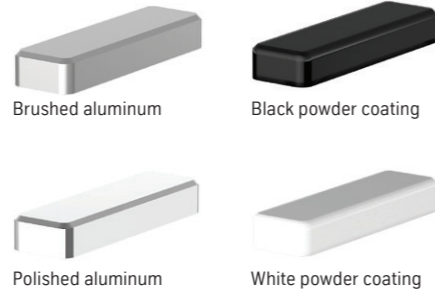

Body
White powder coating Black powder coating

Distance from wall

Large kiosk

Small kiosk

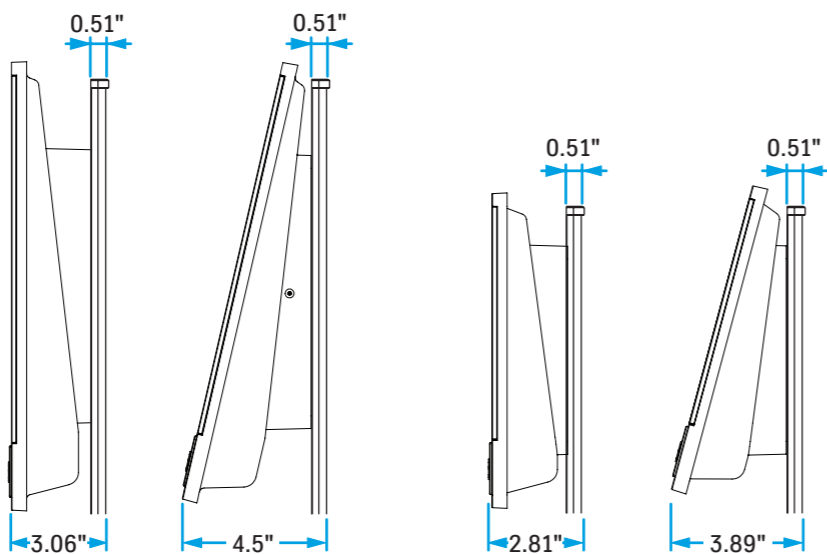

Contact your local thyssenkrupp representative regarding local building code requirements.

Full-height

Half-height

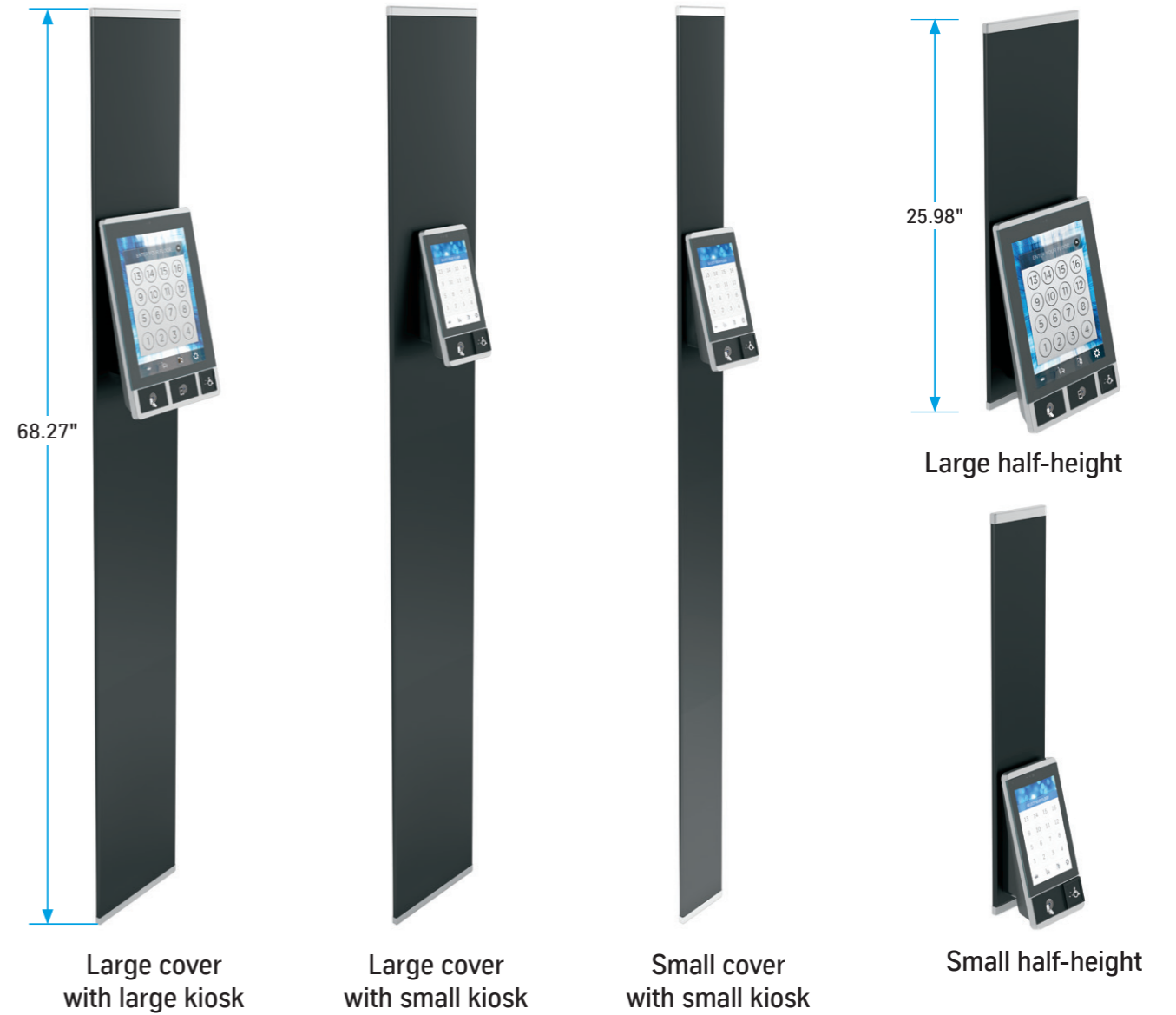

Slim wall cover dimensions

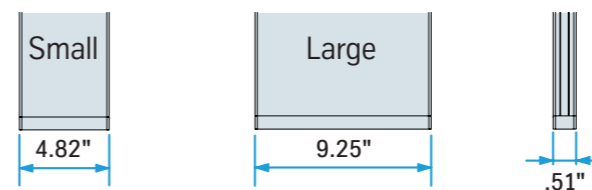

Wall covers are mounted so that the center line of the ADA button maintains 42" above finished floor.

Slim, low profile cover is available in both full- and half-height wall mounts configurations — which hug the wall tightly and only protrude a half-inch off the wall.

Additional devices

Hall target indicators

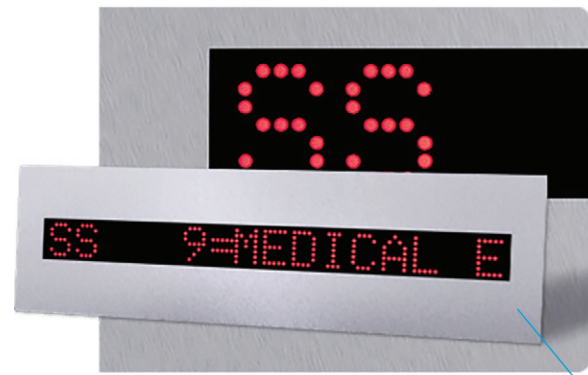

Our elevator hall target indicators clearly display the listed destinations for passengers. They come in a variety of shapes and sizes and you can choose from a selection of display options — including standard lighted numbers, digital readouts and scrolling message displays.

Custom sizes and layouts (vertical mount, long horizontal mount, oversize face plates) are available. We also offer a combination hall lantern/position indicator. These indicators can be built into a hall fixture or can be a standalone unit.



Floor and elevator identification

Hall flags



Option 1
Rounded flag style on stainless



Option 3
Curved opaque sign on stainless



Option 2
Squared flag style on stainless



Option 4
Angled sign on stainless

Braille

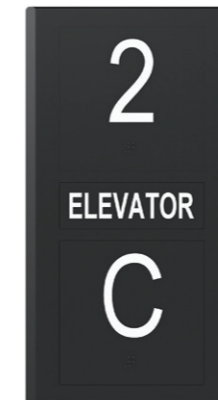

Option 1
Braille and elevator identification plates mounted in frame



Option 2
Combination braille, elevator car identification on a single plate



In-car devices

Car target indicators

Located in the elevator car door jamb, this indicator has multiple uses that are important in both traditional (ETA) and destinational dispatching (ETD). This device can act as a car riding lantern in ETA mode to indicate direction of travel. In ETD mode, the device acts as a car target indicator and gives a visual confirmation of the destination floors.

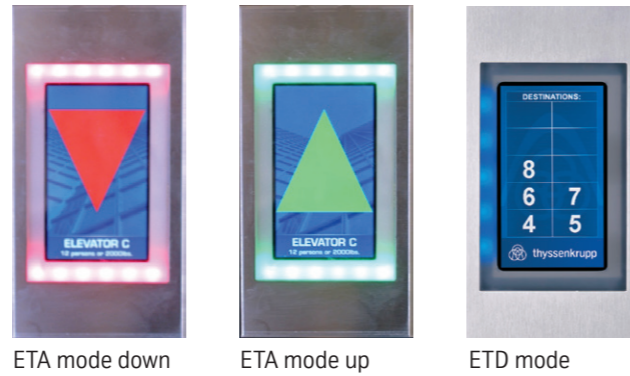

ETA mode down

ETA mode up

ETD mode

Car Operating Panel (COP) options

Destination Select



Destination Complete



Destination Select

On the Destination Select COP, all floor buttons are visible to allow passengers to select their destination, as kiosks are only located on select floors.

Destination Complete

On the Destination Complete COP, there are no exposed floor buttons inside the elevator car because floor destinations are selected at the kiosk.

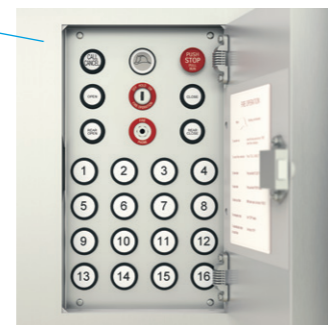

Fire service panel

This fire service panel allows emergency personnel to control the elevator from inside the car during an emergency situation.



Featured: Destination Complete COP with concealed buttons and jamb-mounted car target indicator, confirming destination for passengers.

Elevator Technology

thyssenkrupp Elevator Corporation
2591 Dallas Parkway, Suite 600
Frisco, TX 75034
P: +1 844 427 5461
www.thyssenkruppelevator.com



engineering.tomorrow.together.

All illustrations and specifications are based on information in effect at time of publication approval.
thyssenkrupp Elevator reserves the right to change specifications or design and to discontinue items without prior notice or obligation.
© 2017 thyssenkrupp Elevator Corporation. CA License #C11-651371 | 4878 | AGILE – Destination Control brochure